

EN: INSTALLATION MANUAL Galvanic Isolator VDI-16, VDI-32 and VDI-64

1. Mounting location



Warning!

For safety purposes, the product should be installed in a heat-resistant environment. Avoid the presence of e.g. chemicals, synthetic components, curtains or other textiles in the immediate vicinity of the product.

- 1.1. Install the galvanic isolator in a well ventilated area.
- 1.2. Keep a clear space of 10 cm around the product for ventilation.
- 1.3. The galvanic isolator must be mounted with its length vertical to allow for maximum cooling. Under normal circumstances, the temperature increase of the heat sink is not more than 20°C. However, the unit may become hot when conducting fault ground current.

2. Installation



Warning!

The galvanic isolator must be wired into the green (safety) grounding conducting connection ahead of all grounding connections to the vessel such that no ground connections on the vessel bypass the galvanic isolator making it ineffective.

- 2.1. Connections and safety features must be according to the locally applicable regulations.
- 2.2. Use electric cables of the appropriate size.
- 2.3. Wire the galvanic Isolator into the green (safety) grounding conducting connection as shown in fig. 1.

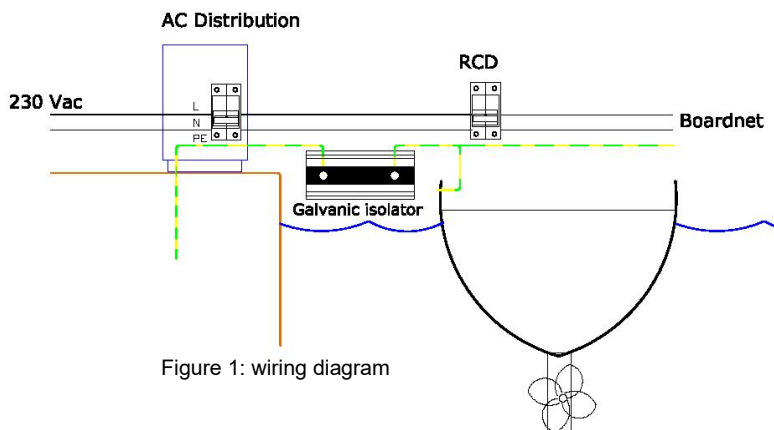

	VDI-16	VDI-32	VDI-64
Galvanic Isolator	Waterproof (potted)		
Maximum current	16 A	32 A	64 A
Peak current (20 ms)	1600 A	3200 A	6000 A
Connection	M6	M6	M6
Heat sink			
Material	Anodized aluminium		
Protection category	IP 67		
Weight	1 kg	2 kg	3,2 kg
Dimensions (hxxxd) VDI-16	60 x 120 x 200 mm		
Dimensions (hxxxd) VDI-32	63 x 164 x 200 mm		
Dimensions (hxxxd) VDI-64	63 x 164 x 335 mm		

NL: INSTALLATIEHANDLEIDING Galvanische isolator

1. Montageplaats



Waarschuwing!

Om veiligheidsredenen dient dit product te worden geïnstalleerd in een hittebestendige omgeving. Voorkom daarom de aanwezigheid van bijvoorbeeld chemicaliën, synthetische onderdelen, gordijnen of ander textiel in de directe omgeving van het product.

- 1.1. Installeer de galvanische isolator in een goed geventileerde ruimte.
- 1.2. Houd rondom het product een ruimte van 10 cm vrij voor ventilatie.
- 1.3. De galvanische isolator moet verticaal worden gemonteerd om een optimale koeling te bereiken. Onder normale omstandigheden bedraagt de temperatuurstijging van het koellichaam niet meer dan 20°C. De unit kan echter heet worden door kortsluitstromen.

2. Installatie



Waarschuwing!

De galvanische isolator moet worden aangesloten op de groene (veiligheids-) aarddraad vóór alle aardingsverbindingen met het schip, zodat geen aardingsverbinding van het schip de galvanische isolator kan omzeilen en deze daardoor ineffectief wordt.

- 2.1. Aansluitingen en veiligheidsmaatregelen moeten worden uitgevoerd in overeenstemming met de plaatselijk van toepassing zijnde regelgeving.
- 2.2. Gebruik elektrische kabels van een juiste doorsnede.
- 2.3. Verbind de galvanische isolator met de groene (veiligheids-) aarddraad, zoals aangegeven in afb. 1.

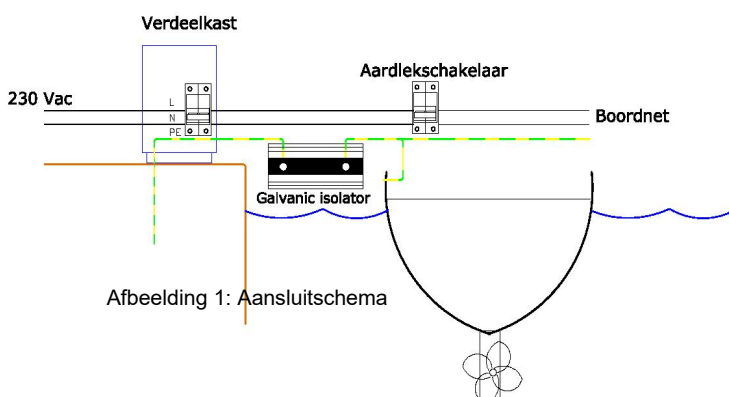

	VDI-16	VDI-32	VDI-64
Galvanische isolator	Waterdicht (ingekapseld)		
Maximale spanning	16 A	32 A	64 A
Piekstroom (20 ms)	1600 A	3200 A	6000 A
Aansluiting	M6	M6	M6
Koellichaam			
Materiaal	Geanodiseerd aluminium		
Beschermingsklasse	IP 67		
Gewicht	1 kg	2 kg	3,2 kg
Afmetingen (hxbxd) VDI-16	60 x 120 x 200 mm		
Afmetingen (hxbxd) VDI-32	63 x 164 x 200 mm		
Afmetingen (hxbxd) VDI-64	63 x 164 x 335 mm		

FR: MANUEL D'INSTALLATION Isolateur Galvanique VDI-16, VDI-32 et VDI-64

1. Lieu de montage



Attention !

Pour des raisons de sécurité, l'appareil doit être installé dans un environnement résistant à la chaleur. Éviter la présence de produits chimiques, de composants synthétiques, de rideaux ou d'autres textiles, à proximité de l'appareil.

- 1.1. Installer l'isolateur galvanique dans un endroit bien ventilé.
- 1.2. Conserver un espace libre de 10 cm autour de l'appareil pour la ventilation.
- 1.3. L'isolateur galvanique doit être installé sur sa longueur en vertical pour permettre un refroidissement maximal. Dans des conditions normales, l'augmentation de la température du radiateur n'est pas de plus de 20 °C. Cependant, l'unité pourrait se chauffer en transportant un courant de défaut à la terre.

2. Installation



Attention !

L'isolateur galvanique doit être branché sur la connexion en vert de mise à la terre (sécurité) avant toutes les connexions de mise à la terre du navire, de telle manière qu'aucune connexion de mise à la terre sur ce navire ne contourne l'isolateur galvanique et ne le rende inefficace.

- 2.1. Les raccordements et les dispositifs de protection doivent être conformes à la réglementation locale en vigueur.
- 2.2. Utiliser des câbles électriques de la taille appropriée.
- 2.3. Brancher l'isolateur galvanique sur la connexion à la terre en vert (sécurité) comme il est montré sur le schéma 1.

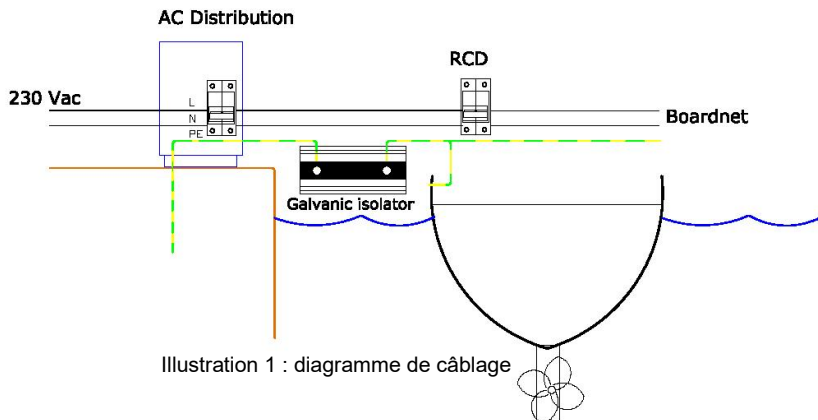

Illustration 1 : diagramme de câblage

	VDI-16	VDI-32	VDI-64
Isolateur galvanique	Résistant à l'eau (encapsulé)		
Courant maximal	16 A	32 A	64 A
Courant de crête (20 ms)	1600 A	3200 A	6000 A
Connexion	M6	M6	M6
Radiateur			
Matériau	Aluminium anodisé		
Degré de protection	IP 67		
Poids	1 kg	2 kg	3,2 kg
Dimensions (H x L x P) VDI-16	60 x 120 x 200 mm		
Dimensions (H x L x P) VDI-32	63 x 164 x 200 mm		
Dimensions (H x L x P) VDI-64	63 x 164 x 335 mm		

DE: INSTALLATIONSHANDBUCH GALVANISCHER TRENNER VDI-16, VDI-32 und VDI-64

1. Installationsort



Achtung!

Aus Sicherheitsgründen sollte das Gerät vor übermäßiger Hitze geschützt werden. Stellen Sie sicher, dass keine brennbaren Chemikalien, Plastikteile, Vorhänge oder andere Textilien in unmittelbarer Nähe des Gerätes sind.

- 1.1. Installieren Sie den galvanischen Trenner an einem gut belüfteten Ort.
- 1.2. Lassen Sie aus Ventilationsgründen rund um das Gerät mindestens 10 cm frei.
- 1.3. Der galvanische Trenner muss mit seiner Länge vertikal montiert werden, um die maximale Kühlung zu ermöglichen. Unter normalen Umständen beträgt der Temperaturanstieg des Kühlelements nicht mehr als 20 C. Jedoch kann das Gerät heiß werden, wenn ein Erdfehlerstrom durchgeleitet wird.

2. Installation



Achtung!

Der galvanische Trenner muss mit dem grünen (Sicherheits-) Erdungsleiteranschluss vor Anschluss aller Erdungsanschlüssen mit dem Schiff verbunden werden, damit keiner der Erdungsanschlüsse am Schiff den galvanischen Trenner umgehen kann und diesen dann unwirksam macht.

- 2.1. Anschlüsse und Sicherheitsvorkehrungen müssen den örtlich geltenden Bestimmungen entsprechen.
- 2.2. Verwenden Sie Kabel mit der geeigneten Größe.
- 2.3. Verbinden Sie den galvanischen Trenner mit dem grünen (Sicherheits-) Erdungsleiteranschluss wie in Abbildung 1 gezeigt.



Abbildung 1: Schaltbild

	VDI-16	VDI-32	VDI-64
Galvanischer Trenner	Wasserdicht (vergossen)		
Maximaler Strom	16 A	32 A	64 A
Spitzenstrom (20 ms)	1600 A	3200 A	6000
Anschluss	M6	M6	M6
Kühlelement			
Material	eloxiertes Aluminium		
Schutzklasse	IP 67		
Gewicht	1 kg	2 kg	3,2 kg
Maße (HxBxT) VDI-16	60 x 120 x 200 mm		
Maße (HxBxT) VDI-32	63 x 164 x 200 mm		
Maße (HxBxT) VDI-64	63 x 164 x 335 mm		

ES: MANUAL DE INSTALACIÓN Aislador Galvánico VDI-16, VDI-32 y VDI-64

1. Lugar de montaje

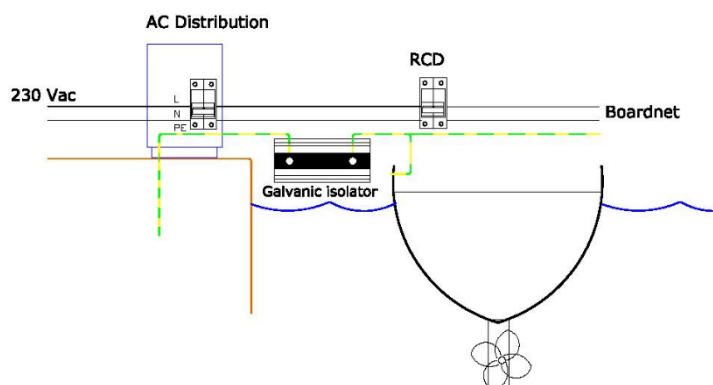

¡Aviso!

Por motivos de seguridad, este producto debe instalarse en un entorno resistente al calor. Debe evitarse en su proximidad la presencia de productos químicos, componentes sintéticos, cortinas u otros textiles.

- 1.1. Instale el aislador galvánico en un lugar bien ventilado.
- 1.2. Deberá dejarse un espacio de al menos 10 cm. alrededor del producto para ventilación.
- 1.3. El aislador galvánico debe montarse en sentido vertical para permitir el máximo de refrigeración. En condiciones normales, el aumento de la temperatura del disipador no supera los 20°C. sin embargo, la unidad puede calentarse cuando circule corriente por fallo de la puesta a tierra.

2. Instalación



¡Aviso!

El aislador galvánico debe conectarse al cable de conexión a tierra verde (seguridad), antes de realizar cualquier otra conexión a tierra del barco, de manera que ninguna conexión a tierra del barco sobrepase el aislador galvánico, inutilizándolo.

- 2.1. Tanto las conexiones como las medidas de seguridad deben realizarse según las normativas locales aplicables.
- 2.2. Utilice cables eléctricos de un tamaño adecuado.
- 2.3. Conecte el aislador galvánico en el cable de conexión a tierra verde (seguridad), tal y como se muestra en la figura 1



Figura 1: Diagrama de cableado

	VDI-16	VDI-32	VDI-64
Aislador galvánico	Impermeable (encapsulado)		
Corriente máxima	16 A	32 A	64 A
Corriente pico (20 ms)	1600 A	3200 A	6000 A
Conexión	M6	M6	M6
Disipador			
Material	Aluminio anodizado		
Tipo de protección	IP 67		
Peso	1 kg	2 kg	3,2 kg
Dimensiones (al x an x p) VDI-16	60 x 120 x 200 mm		
Dimensiones (al x an x p) VDI-32	63 x 164 x 200 mm		
Dimensiones (al x an x p) VDI-64	63 x 164 x 335 mm		

SE: INSTALLATIONSMANUAL Galvanisk isolator VDI-16, VDI-32 och VDI-64

1. Monteringsplats

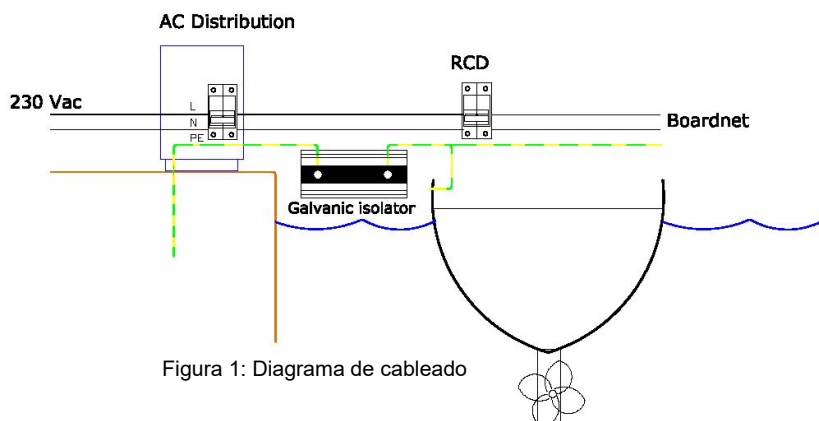

Varning!

Av säkerhetsskäl bör denna produkt installeras i en värmeresistent miljö. Du bör förhindra närvaron av exempelvis kemikalier, syntetiska komponenter, gardiner eller andra textilier m.m. i den omedelbara närheten.

- 1.1. Installera den galvaniska isolatorn på en väl ventilerad plats.
- 1.2. Se till att det är fritt 10 cm runt produkten för ventilation.
- 1.3. Den galvaniska isolatorn måste monteras med den längsta sidan lodrätt för maximal kylning. Vid normala förhållanden överstiger inte temperaturökningen på kylelementet 20 °C. Enheten kan dock bli varm om den leder felaktig jordström.

2. Installation



Varning!

Den galvaniska isolatorn måste kopplas till den gröna (säkra) jordledningsanslutningen före alla andra jordanslutningar på skeppet för att förhindra att andra jordanslutningar leder förbi den galvaniska isolatorn och gör den ineffektiv.

- 2.1. Anslutningar och säkerhetsåtgärder måste utföras i enlighet med lokala föreskrifter.
- 2.2. Använd elkablar av rätt storlek.
- 2.3. Koppla den galvaniska isolatorn till den gröna (säkra) jordledningsanslutningen så som visas i fig. 1.

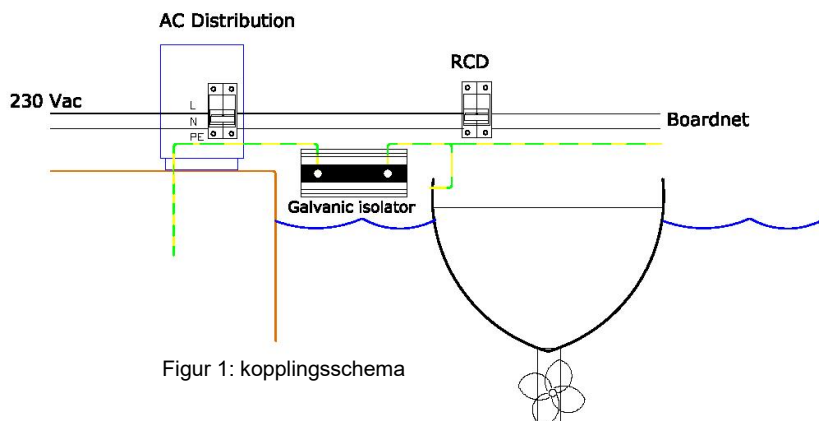

Figur 1: kopplingschema

	VDI-16	VDI-32	VDI-64
Galvanisk isolator	Vattentät (ingjuten)		
Maximal ström	16 A	32 A	64 A
Toppström (20 ms)	1600 A	3200 A	6000 A
Koppling	M6	M6	M6
Kylelement			
Material	Anodiserat aluminium		
Skyddsklass	IP 67		
Vikt	1 kg	2 kg	3,2 kg
Dimensioner (h x b x d) VDI-16	60 x 120 x 200 mm		
Dimensioner (h x b x d) VDI-32	63 x 164 x 200 mm		
Dimensioner (h x b x d) VDI-64	63 x 164 x 335 mm		

IT: MANUALE DI INSTALLAZIONE Isolatore Galvanico VDI-16, VDI-32 e VDI-64

1. Ubicazione di montaggio



Attenzione!

Per ragioni di sicurezza, installare il presente prodotto in un ambiente termo-resistente. Accertarsi che nelle immediate vicinanze non vi siano sostanze chimiche, elementi in materiale sintetico, tende e altri materiali tessili.

- 1.1. Installare l'isolatore galvanico in una zona ben ventilata.
- 1.2. Per garantire una corretta ventilazione, lasciare uno spazio libero di 10 cm attorno al prodotto.
- 1.3. L'isolatore galvanico deve essere montato in modo che la sua parte più lunga si trovi in verticale, per consentire il massimo raffreddamento. In normali circostanze, l'aumento di temperatura del dissipatore di calore non supera i 20 °C. Tuttavia, l'unità potrebbe riscaldarsi quando conduce corrente di guasto a terra.

2. Installazione



Attenzione!

L'isolatore galvanico deve essere cablato alla connessione verde (sicurezza) di conduzione a terra, prima di eseguire tutte le connessioni a terra del natante, in modo che nessuna di queste connessioni a terra del natante aggiri l'isolatore galvanico, rendendolo inefficace.

- 2.1. I collegamenti e le funzionalità di sicurezza devono essere conformi alle normative locali applicabili.
- 2.2. Utilizzare cavi elettrici con una sezione adeguata.
- 2.3. Cablare l'isolatore galvanico alla connessione verde (sicurezza) di conduzione a terra come mostrato nella fig. 1.

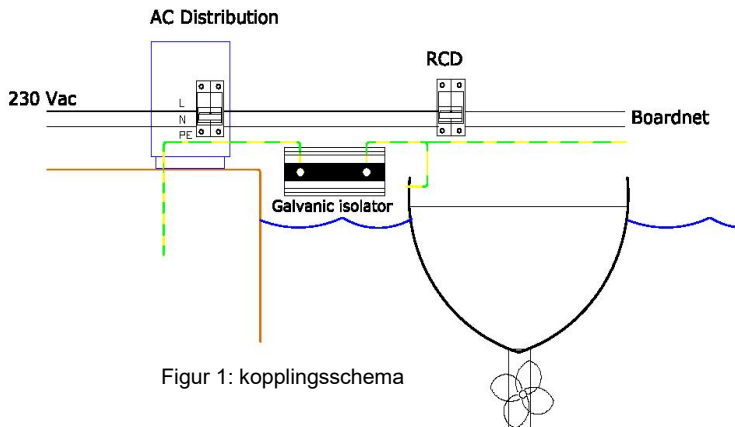

Figur 1: kopplingschema

	VDI-16	VDI-32	VDI-64
Isolatore galvanico	Impermeabile (incapsulato)		
Corrente massima	16 A	32 A	64 A
Corrente di picco (20 ms)	1600 A	3200 A	6000 A
Collegamento	M6	M6	M6
Dissipatore di calore			
Materiale	Alluminio anodizzato		
Categoria protezione	IP 67		
Peso	1 kg	2 kg	3,2 kg
Dimensioni (axlpx) VDI-16	60 x 120 x 200 mm		
Dimensioni (axlpx) VDI-32	63 x 164 x 200 mm		
Dimensioni (axlpx) VDI-64	63 x 164 x 335 mm		

TR: KURULUM KILAVUZU Galvanizli İzolatör VE

1. Montaj konumu



Uyarı!

Güvenlik için, ürün sıcağa dayanıklı bir ortama kurulmalıdır. Kimyasallar, sentetik bileşenler, perdeler veya başka kumaşlar ürünün yakınında bulunmamalıdır.

- 1.1. Galvanizli izolatörü iyi havalandırılan bir yere kurun.
- 1.2. Ürünün etrafında havalandırma için 10 cm'lik boşluk bırakın.
- 1.3. Galvanizli izolatör, maksimum havalandırmaya imkan tanımak için dik monte edilmelidir. Normal koşullarda soğutmanın sıcaklık artışı 20°C'yi geçmez. Ancak, hatalı topraklama akım iletimi sırasında ünite ısınabilir.

2. Kurulum



Uyarı!

Galvanizli izolatör, teknedeki hiçbir topraklama bağlantısının galvanizli izolatörü baypas ederek etkisiz hale getirmemesi için teknedeki diğer tüm topraklama bağlantılarının önündeki yeşil (güvenlik) topraklama iletim bağlantısına bağlanmalıdır.

- 2.1. Bağlantılar ve güvenlik özellikleri geçerli yerel düzenlemelere uygun olmalıdır.
- 2.2. Uygun boyda elektrik kabloları kullanın.
- 2.3. Galvanizli izolatörü, Şekil 1'de gösterildiği gibi yeşil (güvenlik) topraklama iletim bağlantısına bağlayın.

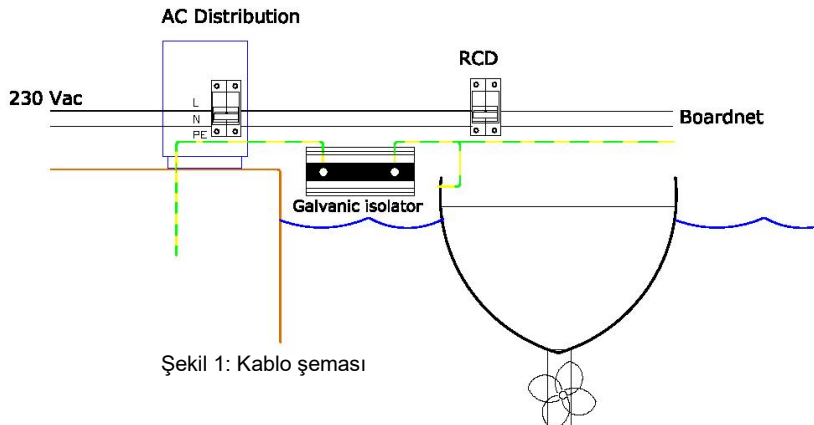

Şekil 1: Kablo şeması

	VDI-16	VDI-32	VDI-64
Galvanizli İzolatör	Su geçirmez (kaplı)		
Maksimum akım	16 A	32 A	64 A
Pik akım (20 ms)	1600 A	3200 A	6000 A
Bağlantı	M6	M6	M6
Soğutma			
Malzeme	Anotlanmış alüminyum		
Koruma kategorisi	IP 67		
Ağırlık	1 kg	2 kg	3,2 kg
Boyutlar (yxgxd) VDI-16	60 x 120 x 200 mm		
Boyutlar (yxgxd) VDI-32	63 x 164 x 200 mm		
Boyutlar (yxgxd) VDI-64	63 x 164 x 335 mm		